



# TRUCK BODY COMPONENTS



## Translucent roof

Offered with either chopped glass or full woven roving reinforcement. Roof panels provide excellent durability and high resistance to damage from tearing and puncture.

- Lightest weight roof panel product available
- Acrylic modified and UV stabilized for resistance to weather and chemicals

### Characteristics:

- Translucent roof panel with UV inhibitors
- Reinforced edges
- Pebbled



Prod. #	Nominal thickness	Width	Roll length	Weight per s.f.	✂
890-3438	0.075"	102"	500'	0.72 lb.	min: 1'
890-5001	0.075"	102"	300'	0.72 lb.	min: 300'

## Liner panel

Panels are engineered with chopped glass or a full width woven roving mat of continuous bi-directionally oriented fiberglass strands and high quality polyester resin.

- High impact resistance.
- Excellent resistance to tearing and puncturing.
- Easier to maintain than plywood or hardwood.

For refrigerated and dry van trailers or truck bodies.



Prod. #	Nominal thickness	Width	Weight per s.f.	Length roll	Characteristics	✂
890-3389	0.090"	96"	0.63 lb.	500'	Standard glass content — Pebble finish	min: 1'
890-5114	0.090"	96"	0.63 lb.	300'	Standard glass content — Pebble finish	min: 300'

REV. 09/2012

### Translucent fiberglass skylight

<sup>3</sup>/<sub>32</sub>" thick translucent fiberglass skylight brings daylight inside the van.  
Easy to install. The rubber mounting ring is completely sealed.

Prod. #	
775-0027	For 16 <sup>3</sup> / <sub>16</sub> " diameter opening



### Aluminum roof sheet

Half-hard aluminum, with good corrosion resistance and easily formed.  
Alloy: 3003H16

Prod. #			Approx. weight/lbs. per linear foot	Weight/lbs. per inch
878-0070	102" X 0.032"	Sold per inch	3.80	0.32

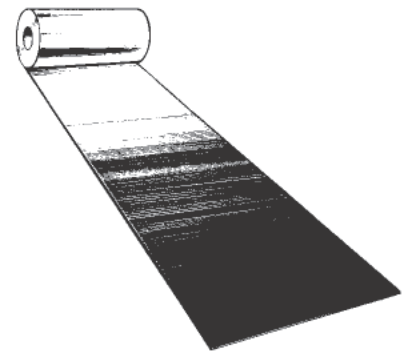

### Aluminum side panels

Smooth polar white one side only.  
PVC covered

Prod. #	Width X length	Thickness	Approx. weight/lbs.
875-1351	49" X 79"	0.040"	15.59
875-1369	49" X 85"	0.040"	16.78
875-1383	49" X 97"	0.040"	19.14
875-1496	49" X 110"	0.040"	21.71

Some parts may be lead time items.  
Consult our sales department for availability.

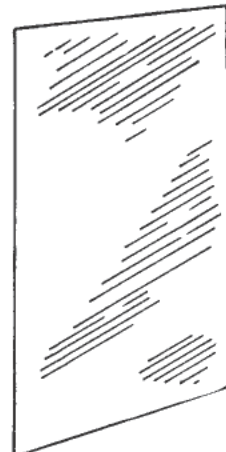

REV. 06/2012

## Air Deflectors



For truck bodies with radius roof cap and corner post

Prod. #	Models	A	B	C	D	Approx. weight/lbs.
880-2408	NC-29 RM	76.00"	79.00"	18.00"	26.00"	40.00
880-2415	NC-29 RM2	83.00"	86.00"	18.00"	26.00"	45.00
880-0263	NC-30 RMN	64.50"	67.50"	24.00"	29.62"	20.00
880-2165	NC-36 RM	74.75"	82.00"	32.00"	38.00"	22.00
880-4035	NC-38 SRM	76.00"	79.00"	25.00"	33.75"	* 30.00
880-4116	NC-38 RM	77.00"	80.75"	27.00"	35.75"	30.00
880-4003	NC-38 RM2	82.75"	86.00"	27.00"	35.75"	34.00
880-4010	NC-38 RM3	88.00"	92.00"	27.00"	36.00"	*** 38.00
880-0217	NC-43 RM	76.00"	80.75"	32.00"	41.25"	40.00
880-0224	NC-43 RM2	81.25"	86.00"	32.00"	41.25"	42.00
880-0288	NC-42 RM	74.50"	83.50"	35.00"	44.00"	** 40.00
880-4109	NC-48 SRM	76.00"	79.00"	35.00"	44.00"	** 40.00
880-4099	NC-48 RM	77.00"	80.75"	37.00"	46.00"	40.00
880-4028	NC-48 RM2	82.75"	86.00"	37.00"	46.00"	44.00
880-4148	NC-48 RM3	90.50"	93.00"	37.00"	46.00"	48.00
880-4081	NC-58 RM	77.00"	81.50"	45.75"	54.75"	50.00
880-4042	NC-58 RM2	82.75"	86.00"	45.75"	54.75"	54.00
880-4067	NC-58 RM3	88.50"	92.00"	45.50"	55.50"	58.00

For truck bodies with radius corners and square roof

Prod. #	Models	A	B	C	D	Approx. weight/lbs.
880-4074	NC-2610 MN	68.50"	72.00"	24.00"	26.00"	25.00
880-0859	NC-36 M	80.50"	86.00"	33.00"	36.00"	• 33.00
880-0337	NC-4410 M3	98.00"	101.00"	42.00"	43.75"	47.00
880-4123	NC-48 M	80.50"	86.00"	45.00"	48.00"	• 38.00
880-6931	NC-48 M2	80.50"	92.00"	45.00"	48.00"	• 45.00
880-0841	NC-60 M6	82.00"	85.25"	57.50"	60.00"	50.00
880-6924	NC-60 M4	98.50"	101.00"	58.00"	60.00"	55.00

Some parts may be lead time items. Consult our sales department for availability.

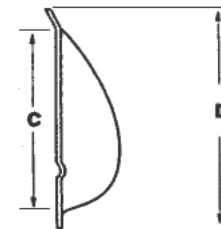
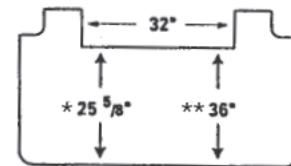
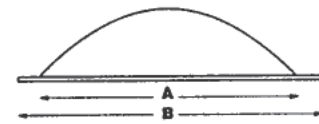

\*\*\* with groove at 26 1/2" from the bottom.

• Model with cutouts for lights

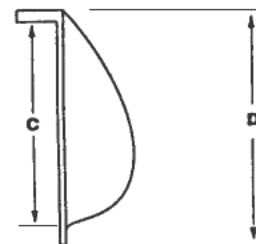

## Air Deflectors

Model with flange adaptable to small vehicles or trailers with square or radius roof

Prod. #	Models	A	B	C	D	Approx. weight/lbs.
880-6917	NC-C36 MX	55.00"	60.00"	33.00"	36.00"	24.00
880-6963	NC-C36 MN	69.00"	72.00"	33.00"	36.00"	28.00
880-0270	NC-C48-MN	69.00"	72.00"	45.50"	48.00"	29.00

Model with flat flanges for installation on front wall only

Prod. #	Models	A	B	C	D	Approx. weight/lbs.
880-6949	NC-C36 M	83.00"	86.25"	32.00"	35.75"	35.00
880-6956	NC-C36 M2	89.00"	92.25"	32.00"	35.75"	39.00

Some parts may be lead time items. Consult our sales department for availability.

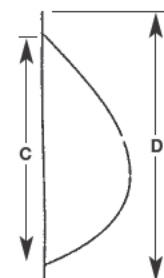

REV. 01/2011

**Air Deflectors**



**For truck bodies (square model)**

Prod. #	Models	B	C	D	E	Approx. weight/lbs.
880-0351	24-96-03	96.25"	22.00"	25.50"	03	30.00
880-0009	24-96-06	96.25"	22.00"	25.50"	06	45.00
880-1235	30-96-03	96.25"	27.00"	30.00"	03	30.00
880-1274	30-102-03	101.50"	27.00"	30.00"	03	38.00
880-1242	30-96-06	96.25"	27.00"	30.00"	06	38.00
880-1281	30-102-06	101.50"	27.00"	30.00"	06	35.00
880-0016	36-96-03	96.25"	32.75"	36.25"	03	50.00
880-2006	36-102-03	102.25"	32.75"	36.25"	03	50.00
880-0023	36-96-06	96.25"	32.75"	36.25"	06	50.00
880-0048	36-102-06	101.50"	32.75"	36.25"	06	50.00
880-0256	42-96-03	96.25"	37.50"	41.00"	03	55.00
880-2020	42-102-03	102.25"	37.50"	41.00"	03	55.00
880-0295	42-96-06	95.50"	37.50"	41.00"	06	55.00
880-0055	48-96-03	95.75"	46.00"	49.00"	03	55.00
880-2038	48-102-03	102.25"	46.00"	49.00"	03	50.00
880-0062	48-96-06	95.75"	46.00"	49.00"	06	50.00
880-0094	48-102-06	101.50"	46.00"	49.00"	06	50.00
880-0584	48-103-03	102.00"	46.00"	49.00"	03	52.00
880-0591	48-103-06	102.00"	46.00"	49.00"	06	52.00
880-2077	54-103-03	102.75"	52.00"	55.50"	03	58.00

**For trailers**

Prod. #	Models	B	C	D	E	Approx. weight/lbs.
880-2246*	68-102-6R	100.50"	64.00"	67.25"	6R	60.00
880-0231	68-96-08	96.50"	64.75"	67.75"	08	60.00
880-0249	68-102-08	101.75"	63.75"	68.50"	08	60.00
880-0175	68-102-8R	100.50"	65.50"	68.75"	8R	60.00
880-0182	68-102-10R	99.75"	63.00"	66.75"	10R	60.00

\* with 7" cut-outs for lights

Models for heated and refrigerated trailers also available on request.

Some parts may be lead time items. Consult our sales department for availability.

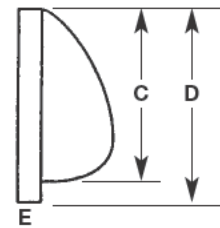
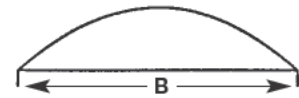

Types of corner posts

**LESS THAN 3"**  
suffix: 03



**LESS THAN 6"**  
suffix: 06



**LESS THAN 8"**  
suffix: 08



**6" RADIUS**  
suffix: 6R

**8" RADIUS**  
suffix: 8R



**10" RADIUS**  
suffix: 10R



**TRUCK BODY COMPONENTS**

**Slip Through the Air with Less Effort**

Air striking curved Nose Cone® is smoothly diverted evenly over the top and around the sides of the truck body or trailer top for better mileage and improved road handling.



Wind drag creates a force against the flat surface of the truck body, as if it were hitting a brick wall. Added horsepower is required to overcome this force, wasting costly fuel.

REV. 04/2013

## Roof rails

Dimensions	mm		in.		Prod. #	Length		Weight lbs.
	mm	in.	mm	in.				
A	57.15	2 1/4"	8 535	336"	875-1721	8 535	336"	26.80
B	44.49	1 3/4"						

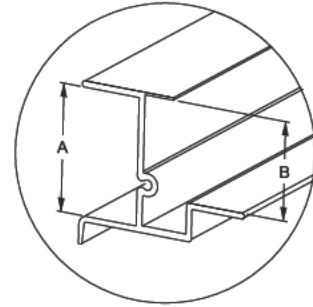

## Lintels

Dimensions	mm		in.		Prod. #	Length		Weight lbs.
	mm	in.	mm	in.				
A	39.85	1 9/16"	7 315	288"	875-2267	7 315	288"	12.94
			8 535	336"	875-2404	8 535	336"	15.09

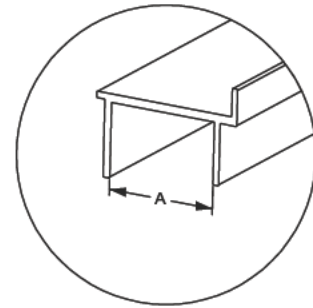

## Roof bows

Dimensions	mm		in.		Prod. #	Length		Weight lbs.
	mm	in.	mm	in.				
ARC	38.10	1 1/2"	2 515	99"	875-3341	2 515	99"	5.51
A	43.65	1 23/64"						
B	31.75	1 1/4"						
C	50.80	2"						

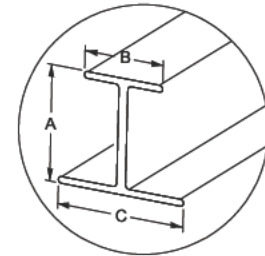

## Rub rail

Dimensions	mm		in.		Prod. #	Length		Weight lbs.
	mm	in.	mm	in.				
A	39.36	1 35/64"	8 560	337"	875-1979	8 560	337"	55.83
B	104.70	4 1/8"						

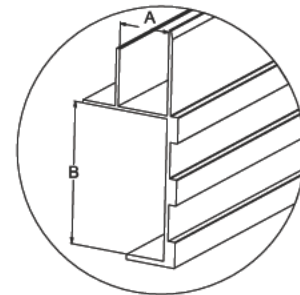

REV. 04/2013

**Top front connector (6" radius corner)**

Dimensions	mm	in.
A	43.43	1 23/32"

Prod. #	Length		Weight lbs.
	mm	in.	
875-0615	2,616	103"	4.97

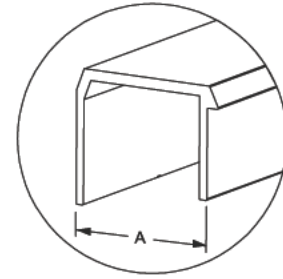

**Front connector (6" radius corner)**

Dimensions	mm	in.
A	37.20	1 15/32"

Prod. #	Length		Weight lbs.
	mm	in.	
875-3510	2,778	109 3/8"	4.50

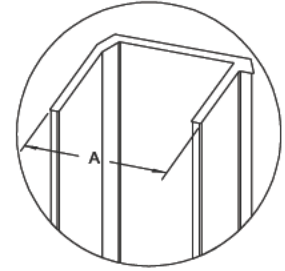

**Top front connector (10" radius corner)**

Dimensions	mm	in.
A	44.44	1 3/4"

Prod. #	Length		Weight lbs.
	mm	in.	
875-1129	2,591	102"	5.32

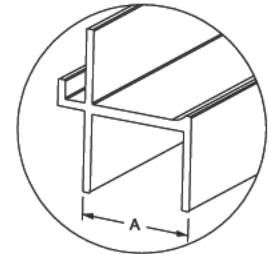

**Front connector (10" radius corner)**

Dimensions	mm	in.
A	37.20	1 15/32"

Prod. #	Length		Weight lbs.
	mm	in.	
875-7184	2,743	108"	5.50

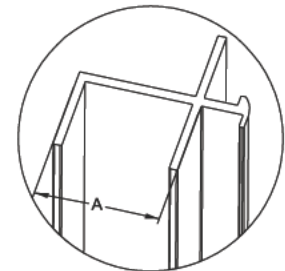

**Rear connector**

Dimensions	mm	in.
A	37.20	1 15/32"

Prod. #	Length		Weight lbs.
	mm	in.	
875-3567	2,754	107 1/4"	4.60

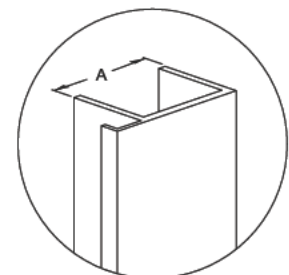

REV. 01/2011

## Z-Posts

Dimensions	mm		in.		Prod. #	Length		Weight lbs.
	mm	in.	mm	in.		mm	in.	
A	35.10	1 13/32"			875-1288	2,159	85"	3.48
B	33.25	1 5/16"			875-1312	2,464	97"	3.81
C	25.40	1"						

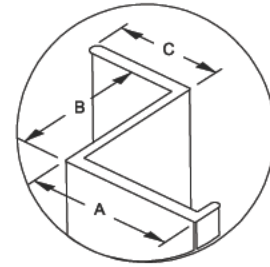

## Corner post (6" radius corner)

Dimensions	mm		in.		Prod. #	Length		Weight lbs.
	mm	in.	mm	in.		mm	in.	
A	31.48	1 15/64"			875-1513	2,794	110"	22.67

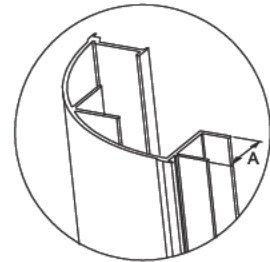

## "J" moulding

Dimensions	mm		in.		Prod. #	Length		Weight lbs.
	mm	in.	mm	in.		mm	in.	
A	20.50	13/16"			875-2877	8,535	336"	1.93
B	5.50	7/32"						

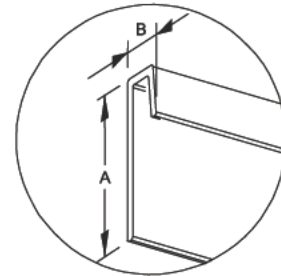

## Side door Z-Post

Prod. #	Length		Weight lbs.
	mm	in.	
875-3373	968	38 1/8"	1.45

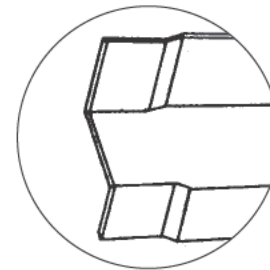

## Rear door Z-Post

Prod. #	Length		Weight lbs.
	mm	in.	
875-2122	968	38 1/8"	1.32

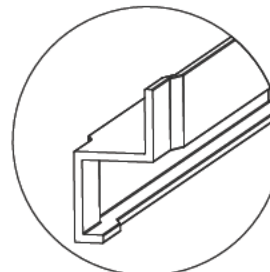

REV. 06/2012



## Door jamb

Dimensions	mm	in.
A	43.30	1 <sup>45</sup> / <sub>64</sub> "
B	128.25	5"
C	30.60	1 <sup>3</sup> / <sub>16</sub> "
D	70.78	2 <sup>25</sup> / <sub>32</sub> "

Prod. #	Length		Weight lbs.
	mm	in.	
875-2940	2,616	103"	10.26

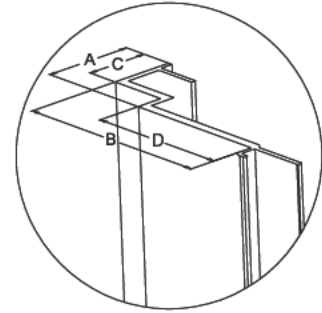

## Rear door frames

Dimensions	mm	in.
A	34.90	1 <sup>3</sup> / <sub>8</sub> "
B	43.43	1 <sup>29</sup> / <sub>32</sub> "
C	61.84	2 <sup>7</sup> / <sub>16</sub> "

Prod. #	Length		Weight lbs.
	mm	in.	
875-0118	2,515	99"	6.02
875-0125	4,470	176"	11.00

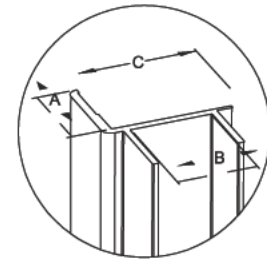

## Side door frame

Dimensions	mm	in.
A	31.72	1 <sup>1</sup> / <sub>4</sub> "
B	35.68	1 <sup>13</sup> / <sub>32</sub> "
C	36.51	1 <sup>7</sup> / <sub>16</sub> "

Prod. #	Length		Weight lbs.
	mm	in.	
875-3084	2,515	99"	6.05

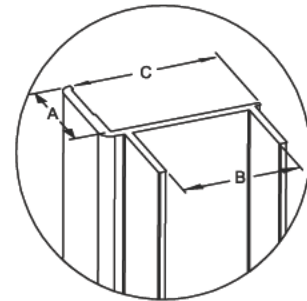

## Door frame for utility bodies

Dimensions	mm	in.
A	23.53	0.92"
B	30.10	1.18"
C	18.80	0.74"

Prod. #	Length		Weight lbs.
	mm	in.	
875-4312	3,658	144"	6.19

To be used with the Faucher hinge # 754-0661 on page D15.

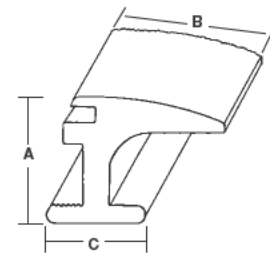

Some parts may be lead time items. Consult our sales department for availability.

REV. 01/2014

## Aluminium gutter

Prod. #: **874-0039**

Length: 18' (216")

Dimensions	mm	in.
A	12.70	1/2"
B	23.81	15/16"
C	22.23	7/8"

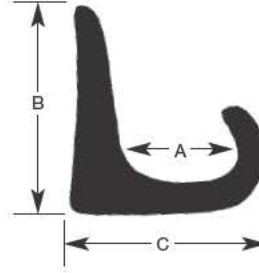

## Aluminium gutter

Prod. #: **874-0014**

Length: 13' (156")

Dimensions	mm	in.
A	6.35	1/4"
B	17.46	11/16"
C	11.11	7/16"

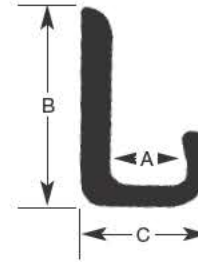

## Reefer drain

Prod. #: **626-0661**

Rubber kazoo: 1 1/4" ID X 5" long neoprene.  
The aluminum drain nipple and drain pipe is not included.



## Chrome gas cap

Prod. #: **776-0000**



## Gas tank filler neck

Prod. #: **776-0025**

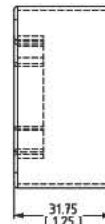
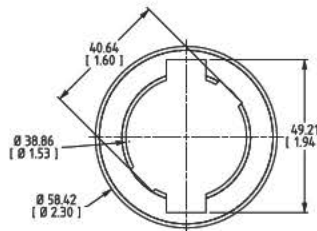

REV: 04/2012

## Placard holders

Slide-N-Glide holders are made of 0.032" anodized aluminum. The installation holes are pre-drilled for quick mounting. The rounded corners ensure the safe use and handling of the holder. The unique designed back panel fitted with ridges allows the placard to be easily removed from the holder over the clip from above. The stainless steel clips function flawlessly over thousands of placard changes. The sturdy construction provides maximum performance and durability for years of use on the road. An affordable way to comply with the requisite warnings for hazardous materials on vehicles.

Prod. #	Dimensions	
776-2008	12 1/2" X 14 1/8"	Anodised aluminum (Min. of 25)
776-0258	12 1/2" X 14 1/8"	White painted aluminum
776-0995		Clip only

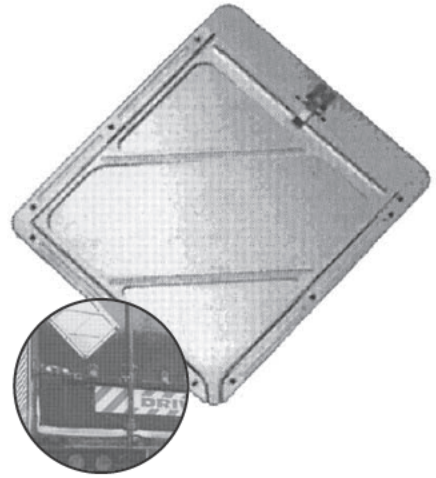

## Small stainless steel placard holder

Prod. #	Dimensions	
776-0032	11 7/8" X 14 1/2"	Stainless steel

Some parts may be lead time items. Consult our sales department for availability.



## Rotary placard holder

Prod. #: **776-3146** White painted aluminum

Two flip charts: 1202 and 1203



## Cables

Prod. #		Length
708-0157	Galvanized steel	110"
708-1739	Stainless steel	110"
708-0171	Galvanized steel	115"
708-0164	Galvanized steel	130"

3/8" eyelet  
Sold in multiples of 25.



## Rollers

Prod. #	Dia.	Shank	Length	
1) 708-0277	1"	7/16"	2 1/2"	
2) 708-0485	2"	7/16"	2 1/2"	
3) 708-2235	2"	7/16"	2 1/2"	(nylon)
4) 708-1778	2"	7/16"	7"	

Sold in multiples of 25.



## Step bolts for hinges

Prod. #		
975-2171	1/4-20 x 1 1/4"	zinc
975-2326	1/4-20 x 1 1/2"	zinc

Sold in box of 100 pcs.  
Nuts not supplied.



## End hinges

Prod. #
A) 708-0686
B) 708-0527
C) 708-2228

Sold in multiples of 25.

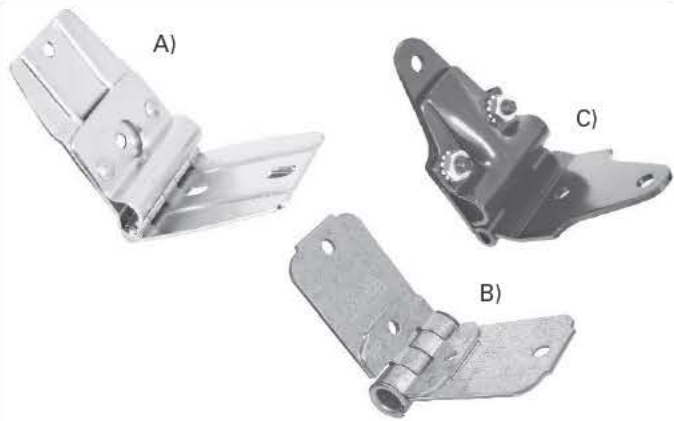

## Centre hinges

Prod. #
A) 708-0661
B) 708-1707
C) 708-2203

Sold in multiples of 25.

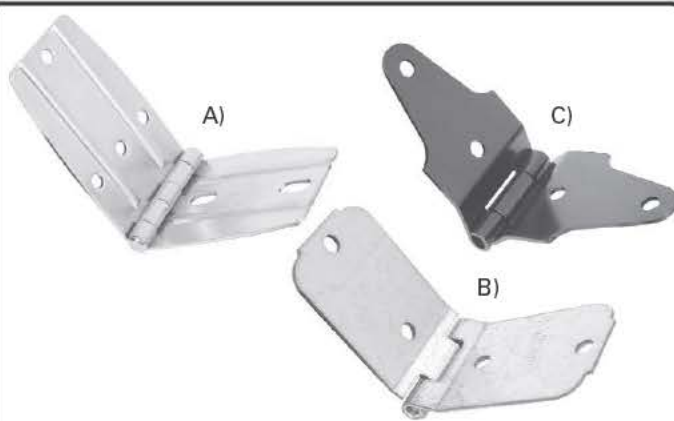

REV. 04/2013