



**RUBBER PRODUCTS**

## Self-sealing setting channel

Prod. #: **620-0140** Roll: 75' (22.9 m)

Sold in multiples of 75'

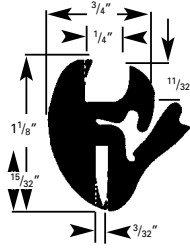

## Self-sealing setting channel

Prod. #: **620-0165**

Roll: 100' (30.1 m)

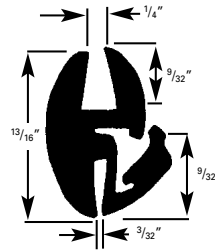

## Glass setting channel

Prod. #: **620-0045**

Roll: 75' (22.9 m)

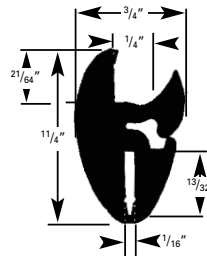

## Glass setting channel

Prod. #: **620-0084**

Roll: 50' (15.2 m)

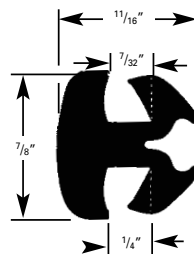

## Wedge to lock glass into channels

Prod. #: **620-0020**

Roll: 75' (22.9 m)

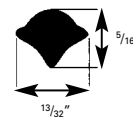

**Flexible channels**

Universal type with inner corrugated steel core.

Prod. #	Length
621-4048	96" (2.4 m)
621-4055	110" (2.8 m)

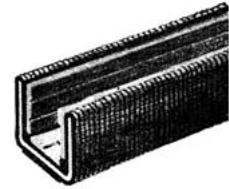
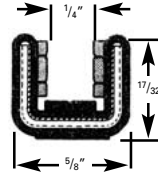

**Stainless steel flexible channel**

Prod. #: 621-4471

With stainless steel sides  
Length: 96" (2.4 m)

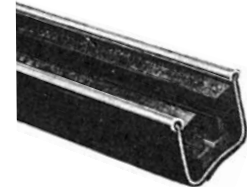
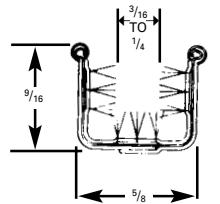

**Division bar**

Prod. #: 621-4506

With side brush for sliding windows  
Length: 72" (1.8 m)

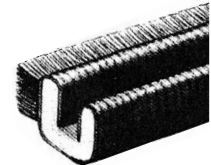
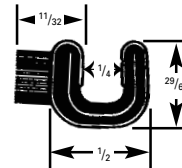

**Rigid channel**

Prod. #: 621-4030

Zinc-plated steel base  
Length: 96" (2.4 m)

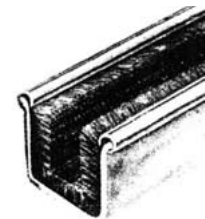
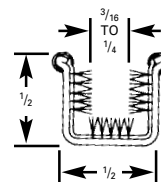

**Flexible twin channel**

Prod. #: 621-4009

Length: 96" (2.4 m)

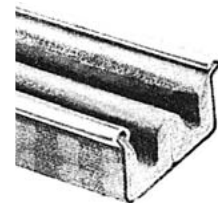
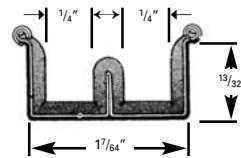

**Stainless steel flexible channel**

Prod. #: 623-4485

Beaded weatherstrip  
Length: 96" (2.4 m)

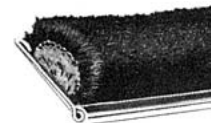
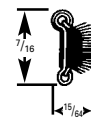

REV. 01/2011

## Glass setting channels

Prod. #	Roll	Dimensions
620-0119	50' (15.2 m)	A: 1 <sup>1</sup> / <sub>32</sub> " B: 1 <sup>1</sup> / <sub>8</sub> " C: 1 <sup>1</sup> / <sub>4</sub> "
620-0126	50' (15.2 m)	A: 7 <sup>7</sup> / <sub>16</sub> " B: 1 <sup>1</sup> / <sub>4</sub> " C: 3 <sup>3</sup> / <sub>64</sub> "

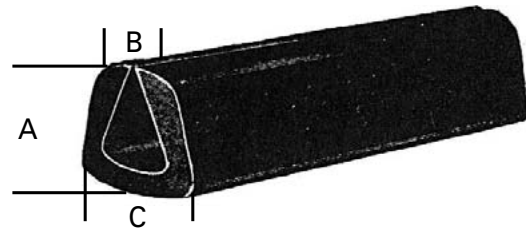

## Glass setting tape

**Everseal:** Made from uncured rubber reinforced with cotton fibers. Slightly sticky to the touch.

Prod. #	Color	Roll	Dimensions
621-0082	Black	100' (30.1 m)	1 <sup>1</sup> / <sub>16</sub> " x 1 <sup>1</sup> / <sub>2</sub> "



## Window throw-out

Prod. #: **681-8191**

With inside handle, to open windows or panels hinged from top. In closed position, it is not possible to open window or panel from the outside.

Made of black nylon-reinforced plastic. Includes a rubber grommet for mounting in glass.

4" T-handle

Length in open position: 9"

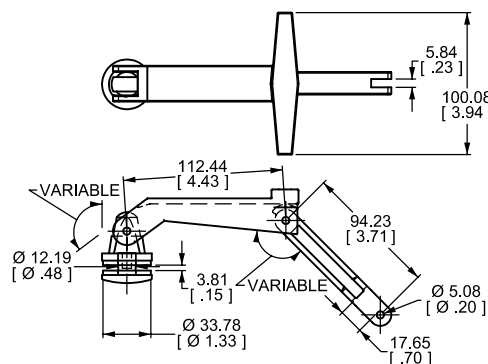

T

RUBBER PRODUCTS

**Rubber weatherstrips**

Low density closed-cell neoprene rubber weatherstrip. Hollow section compresses to 1/4", allowing for tolerances in door adjustment.

Prod. #	Roll	Scissors
623-0258	600' (183 m)	min: 25' (7.6 m)
623-1156*	600' (183 m)	min: 25' (7.6 m)

\* Self adhesive.  
\* Sold in multiples of 25'

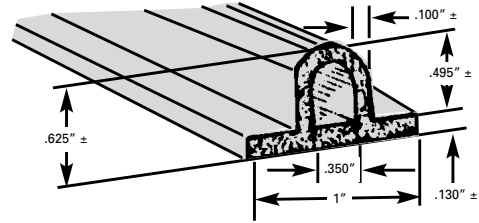

**Rubber weatherstrips**

Universal weatherstrip made of closed-cell neoprene rubber.

Prod. #	Roll	Box:
623-0025	50' (15.2 m)	500' (152.4 m)

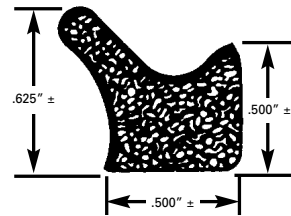

**Rubber weatherstrip**

Prod. #: **623-5009**

EPDM self adhesive weatherstrip.

Roll: 100' (30.1 m)

Sold in multiples of 100'

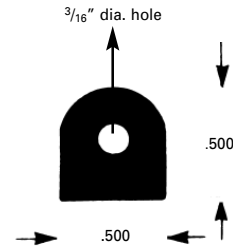

**Garage door rubber weatherstrip**

Garage door rubber weatherstrip made of high quality rubber. Remains flexible in cold weather. Better than similar vinyl products.

Prod. #	Roll	Scissors
623-0240	100' (30.1 m)	min: 25' (7.6 m)

• Some parts may be lead time items. Consult our sales department for availability.

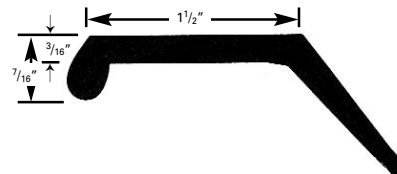

REV. 02/2024

**F**  
**RUBBER PRODUCTS**

## Door seals

Grey edging to seal laminated doors on trailers and containers.  
Dual durometer polymer.

Prod. #	For panel / Thickness	Length
707-0328	3/4"	9' 8"
707-0310	3/4"	14'
707-0335	1"	14'



## Corner seal

45° tabs to seal corner seams

Prod. #	Box of	Length
707-0078 inside edge	20	3 1/16"

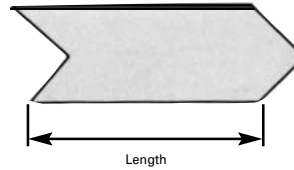

## Acoustical foams

14% perforated vinyl sheet flame-laminated to 1/2" or 1" thick polyester foam. To trim and insulate interior of industrial cabs. Complies with FMVSS 302. Non-adhesive.

Prod. #	Color	
622-0027 - 1/2"	Black	min : 1' (0.30 m)
622-0066 - 1"	Black	min : 1' (0.30 m)

Roll of approx. 150' (45 m) x 54" wide

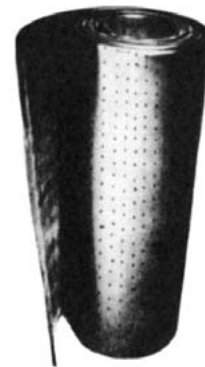

T

RUBBER PRODUCTS

REV. 01/2011

**Closed cell, neoprene weatherstrips**

**Self-adhesive**

Widely used to seal and cushion doors on industrial cabinets, tractors and truck cabs and glass setting.

Oil and water resistant. Black.

UL94HF1 approved.

Meets FMVSS-302 and MIL-R-6130C standards.

(Also available with high tack glue. Used for powder coated metal. Minimum quantity required.)

Prod. #	Thickness	Width	Feet per	
			Roll	Case
623-7609	1/16"	1/2"	100'	2400'
623-7623	1/16"	1"	100'	1200'
623-7655	1/8"	3/8"	50'	1600'
623-7662	1/8"	1/2"	50'	2400'
623-7694	1/8"	3/4"	50'	1600'
623-7704	1/8"	1"	50'	1200'
623-7711	1/8"	1 1/4"	50'	450'
623-7729	1/8"	1 1/2"	50'	400'
623-7736	1/8"	2"	50'	600'
623-7768	3/16"	3/8"	50'	1600'
623-7775	3/16"	1/2"	50'	1200'
623-7782	3/16"	3/4"	50'	800'
623-7817	3/16"	1"	50'	1200'
623-7824	3/16"	1 1/2"	50'	800'
623-7831	1/4"	3/8"	37.5'	1200'
623-7849	1/4"	1/2"	37.5'	900'
623-7856	1/4"	3/4"	37.5'	600'
623-7863	1/4"	1"	37.5'	450'
623-7888	1/4"	1 1/2"	37.5'	300'
623-7895	1/4"	2"	37.5'	225'
623-7905	1/4"	3"	37.5'	150'
623-7937	5/16"	3/4"	30'	480'
623-7944	5/16"	1"	30'	360'
623-7951	5/16"	1 1/2"	30'	240'
623-7969	3/8"	1/2"	25'	600'
623-7976	3/8"	3/4"	25'	400'
623-7983	3/8"	1"	25'	600'
623-8017	3/8"	2"	25'	150'
623-8232	1/2"	1/2"	25'	600'
623-8320	1/2"	3/4"	25'	400'
623-8338	1/2"	1"	25'	300'
623-8345	1/2"	1 1/2"	25'	200'
623-8144	3/4"	3/4"	12.5'	200'
623-8151	3/4"	1"	12.5'	300'
623-8176	3/4"	1 1/2"	12.5'	100'

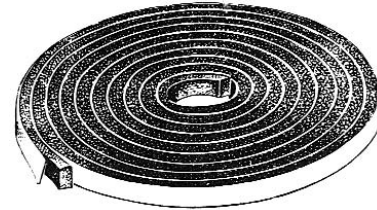

*Sold per case only.*

REV. 01/2014

## Edge trims

Leather-type pattern, snap-on plastic trim with inner flexible metal core.

Positive gripping locks trim over edge.

Prod. #	Color	For material up to	Roll	Scissors
<b>622-4462</b> Double lips	Black	5/32"	165' (50 m)	min: 55' (16.7 m)
Sold in multiples of 55'				
<b>622-0186</b> Double lips	Black	1/8"	50 m (164')	min: 5 m (16.4')
Sold in multiples of 5 m				

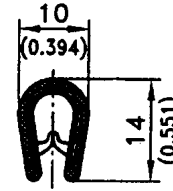
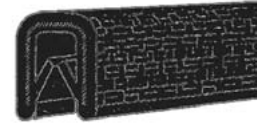
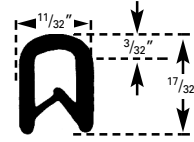

## Edge trim

Leather-type pattern, snap-on plastic trim with inner flexible metal core.

Positive gripping locks trim over edge.

Prod. #	Color	For material up to	Roll	Scissors
<b>622-4494</b> Double lips	White	1/8"	100' (30 m)	min: 25' (7.6 m)

Sold in multiples of 25'

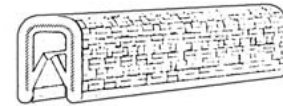
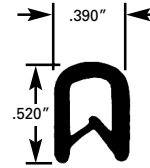

## Edge trim

Leather-type pattern, snap-on plastic trim with inner flexible metal core.

Positive gripping locks trim over edge.

Prod. #	Color	For material up to	Roll	Scissors
<b>622-4014</b> Double lips	Black	1/4"	125' (38.1 m)	min: 25' (7.6 m)

Sold in multiples of 25'

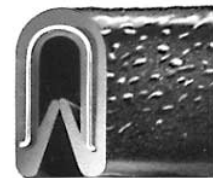
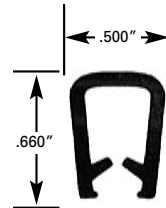

## Edge trim

Leather-type pattern, snap-on plastic trim with inner flexible metal core.

Positive gripping locks trim over edge.

Prod. #	Color	For material up to	Roll	Scissors
<b>622-4487</b> Single lip	Black	3/16"	100' (30 m)	min: 100' (30 m)

Sold in multiples of 100'

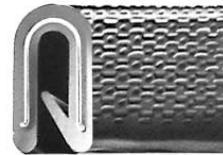
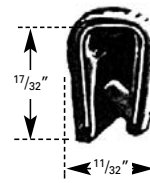



Edge trims with weatherstrip

Prod. #	Color	For material up to	Roll
623-1357	Black	1/16"	25' (7.6 m)
623-4566	Black	1/8"	25' (7.6 m)

Sold in multiples of 25'

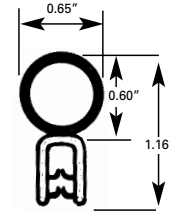

Edge trim with weatherstrip

Prod. #	Color	For material up to	Roll	Scissors icon
623-4460	Black	1/16"	165' (50.3 m)	min: 55' (16.7 m)

Sold in multiples of 55'

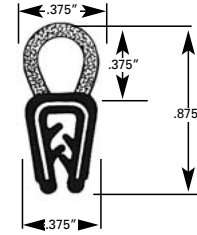

Edge trim with weatherstrip

Prod. #	Color	For material up to	Roll	Scissors icon
622-4455	Black	1/8"	100' (30.5 m)	min: 25' (7.6 m)

Sold in multiples of 25'

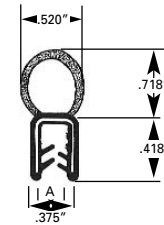

Edge trim with weatherstrip

Prod. #	Color	For material up to	Roll	Scissors icon
623-4414	Black	1/8"	164' (50 m)	min: 41' (12.6 m)

Sold in multiples of 41'

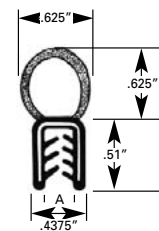

Edge trim with weatherstrip

Prod. #	Color	For material up to	Roll	Scissors icon
623-0138	Black	1/4"	300' (90 m)	min: 25' (7.6 m)

Sold in multiples of 25'

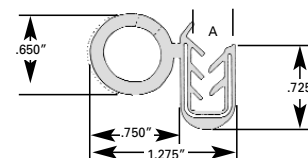

REV. 04/2018

F

RUBBER PRODUCTS

## Edge trim with weatherstrip

With closed cell neoprene bulb seal.

Prod. #	Color	For material up to	Roll	Scissors
623-4478	Black	1 <sup>1</sup> / <sub>64</sub> "	165' (50.3 m)	min: 55' (16.7 m)

Sold in multiples of 55'

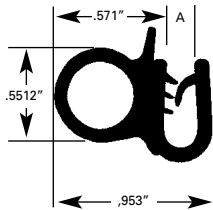

## Edge trim with weatherstrip

Prod. #	Color	For material up to	Roll	Scissors
623-6683	Black	1/8"	750' (228.5 m)	min: 25' (7.6 m)

Sold in multiples of 25'

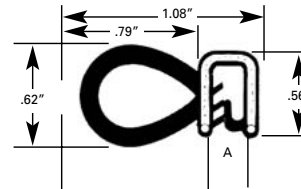

## Edge trim with weatherstrip

Prod. #	Color	For material up to	Roll	Scissors
622-0002	Black	1/8"	25 m (82')	min: 5 m (16.4')

Sold in multiples of 5 m

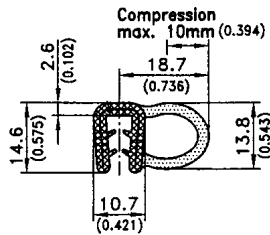

## Edge trim with weatherstrip

Prod. #	Color	For material up to	Roll	Scissors
622-0179	Black	5/32"	75 m (246')	min: 5 m (16.4')

Sold in multiples of 5 m

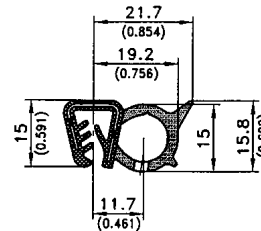

## Edge trim with weatherstrip

Prod. #	Color	For material up to	Roll	Scissors
623-4453	Black	1/8"	82' (25 m)	min: 41' (12.5 m)

Sold in multiples of 41'

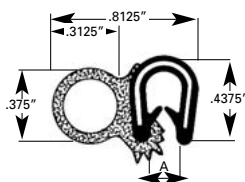

## Edge trim with weatherstrip

Prod. #	Color	For material up to	Roll	Scissors
622-0041*	Black	1/8"	50 m (164')	min: 5 m (16.4')

\*NBR (nitrile), oil and fuel resistant.

Sold in multiples of 5 m

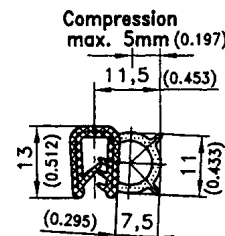

RUBBER PRODUCTS

**Weatherstrip**

Spring steel flexible core covered with closed-cell neoprene rubber. Used to seal irregular surfaces between engine and cab on heavy equipment.

90° mounting

Prod. #	Roll	
623-0096	200' (60.1 m)	min: 25' (7.6 m)

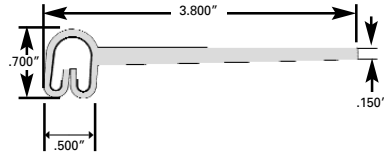

**Weatherstrip**

Spring steel flexible core covered with closed-cell neoprene rubber. Used to seal irregular surfaces between engine and cab on heavy equipment.

In-line mounting

Prod. #	Roll	
623-0071	125' (38.1 m)	min: 25' (7.6 m)

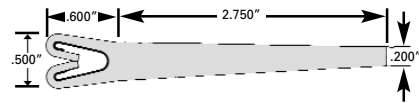

• Some parts may be lead time items. Consult our sales department for availability.

**Weatherstrip**

Spring steel flexible core covered with closed-cell neoprene rubber. Used to seal irregular surfaces between engine and cab on heavy equipment.

Prod. #	Roll	
623-0089	200' (60.1 m)	min: 25' (7.6 m)

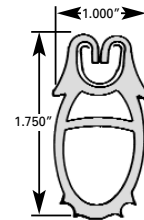

**Accordion cab-to-cab weatherstrip**

Spring steel flexible core covered with closed-cell neoprene rubber.

Prod. #	Roll	
623-6556	150' (45.7 m)	min: 25' (7.6 m)

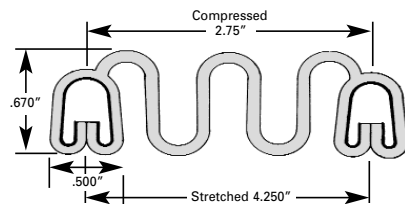

**Accordion cab-to-cab weatherstrip**

Spring steel flexible core covered with closed-cell neoprene rubber.

Prod. #	Roll	
623-6595	100' (30.5 m)	min: 25' (7.6 m)

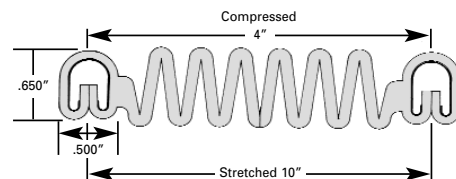

REV. 06/2012

**F**

**RUBBER PRODUCTS**

## Rubber fender

Prod. #	Roll	✂
627-0003	52' (15.8 m)	min: 26' (7.92 m)

Sold in multiples of 26'

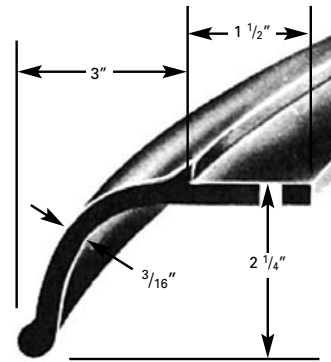

## Rubber fender

Prod. #	Roll	✂
627-1889	52' (15.8 m)	min: 26' (7.92 m)

Sold in multiples of 26'

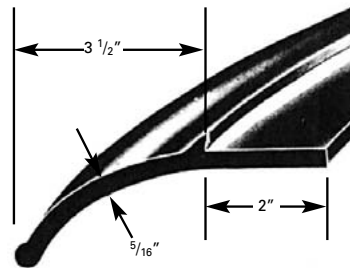

## Rubber fender

Prod. #	Roll	✂
627-1906	100' (30.1 m)	min: 20' (6.10 m)

Sold in multiples of 20'

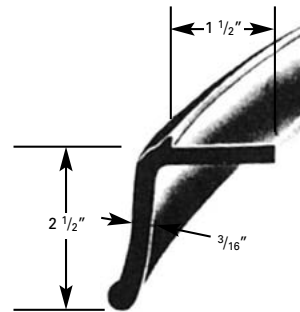

## Rubber fender

Prod. #	Roll	✂
627-1896	100' (30.1 m)	min: 20' (6.10 m)

Sold in multiples of 20'

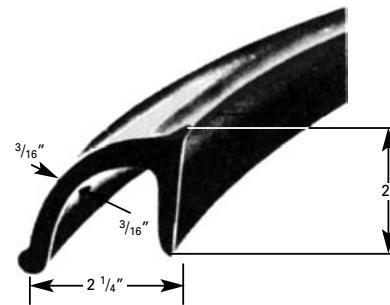

## Rubber fender

Prod. #	Roll	✂
627-0557	50' (15.8 m)	min: 25' (7.62 m)

Sold in multiples of 25'

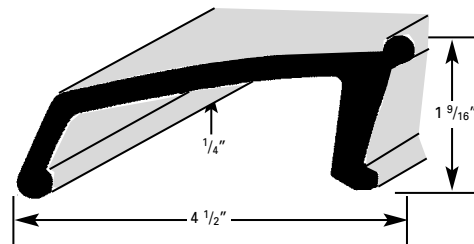

REV. 02/2024

### Molded fender

Prod. #: **627-0500**

Light and tough.  
No painting required and will not rust.  
Color: Black  
Sold in multiples of 2.

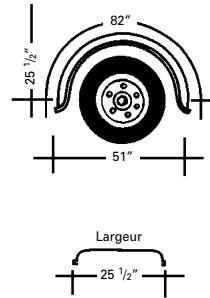

### Heavy duty rubber mud flap

Prod. #: **627-2434**

24" x 30"



### Heavy duty rubber mud flap

Prod. #: **627-0758**

With rain trapper  
24" x 30"/27"/24"



### Light duty rubber mud flap

Prod. #: **627-0067**

24" x 24"



REV. 01/2011

**F**

**RUBBER PRODUCTS**

## Black rubber mattings

Stay flexible to -40°C  
Not to be compared with lower-priced vinyl mattings.

Prod. #	Size	✂
626-0439	1/8" x 36"	Sold in
626-0090	1/8" x 48"	multiples
626-0037	1/4" x 36"	of 5 yards

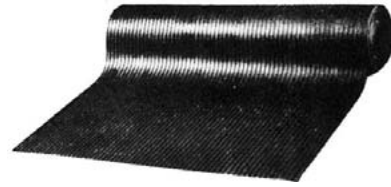

Roll of approx. 25 yards (75')

## Pebble embossed vinyl matting

Sponge matting

Prod. #	Color	Size	Roll	✂
622-0059	Black	1/4" x 60"	90' (27.5 m)	min: 1' (0.30 m)

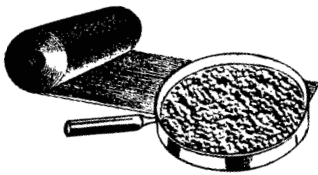

## Self-adhesive anti-skid tape

Black

Prod. #	Size
900-2588	1" x 60'
900-2556	2" x 60'
900-2549	4" x 60'
900-2595	6" x 60'
900-2605	12" x 60'



## PVC interlocking tile

Prod. #: **626-1383** Black 12" x 12"

Thickness 3/4"  
Sold per box of 32.

Male side edge

Prod. #	Colors
626-0213	Black
626-0189	Red
626-0132	Yellow

Female side edge

Prod. #	Colors
626-0220	Black
626-0196	Red
626-0171	Yellow

Prod. #: **626-1400** Black 12" x 12"

Prod. #: **626-0206** Blue 12" x 12"

Prod. #: **626-0238** Red 12" x 12"

Thickness 9/16"  
Sold per box of 36.

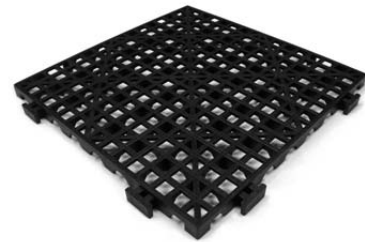

T

RUBBER PRODUCTS

REV. 02/2023

**Vibration mount bumper**

Prod. #: **847-0417** DURO-40

Vibration mount bumper with inside thread of  $\frac{3}{8}$  - 16.

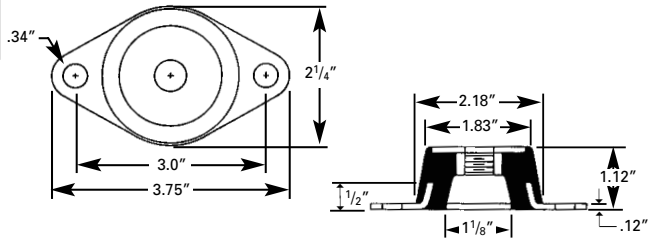

**Small rubber bumper**

Prod. #: **624-4194**

Black

\* Some parts may be lead time items. Consult our sales department for availability.

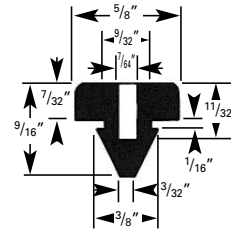

**Small rubber bumper**

Prod. #: **624-6003**

Black

Minimum of 50

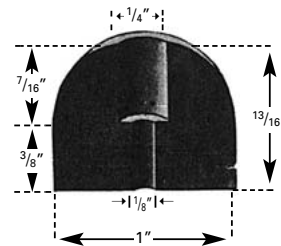

**Small rubber bumper**

Prod. #: **624-0030**

Black

Minimum of 50

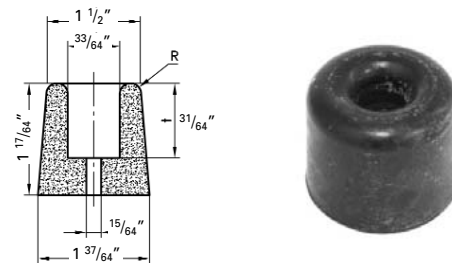

**Small rubber bumper**

Prod. #: **624-6035**

Black

Minimum of 50

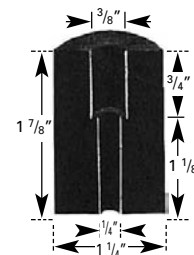

**Small rubber bumper**

Prod. #: **624-6028**

Black

Minimum of 50

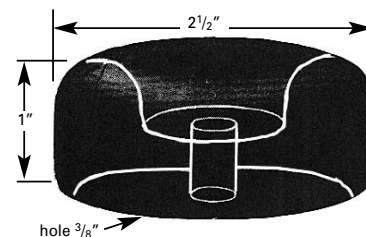

REV. 02/2023

## Rubber bumper

Prod. #: 625-6053

A: 4 7/8"  
 B: 3 1/2"  
 C: 3 1/8"  
 Holes: D: 1/2"  
 E: 2 1/2"

Minimum of 12

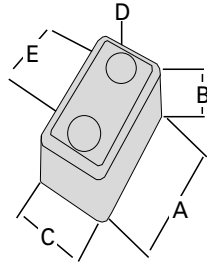

## Rubber bumper

Prod. #: 625-6127

A: 6  
 B: 3 1/2"  
 C: 2 7/8"  
 Holes: D: 1/2"  
 E: 3"

Minimum of 12

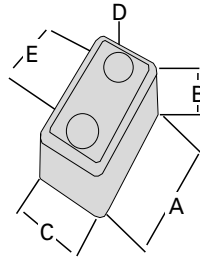

## Rubber bumper

Prod. #: 625-6102

A: 6  
 B: 3 1/4"  
 C: 3 15/16"  
 Holes: D: 1/2"  
 E: 2 1/2"

Minimum of 16

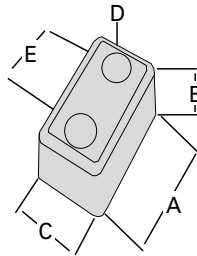

## Rubber bumper

Prod. #: 625-6046

A: 7 3/4"  
 B: 3 1/8"  
 C: 3"  
 Holes: D: 1/2"  
 E: 3 3/8"

Minimum of 12

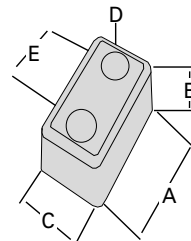

\* Personalize your bumpers with your logo (minimum order required).

REV. 02/2024



### Rubber bumper

Prod. #: 625-0024

A: 16"  
B: 2"  
C: 2 3/8"  
Holes: D: 3/8"  
E: 6 1/2"

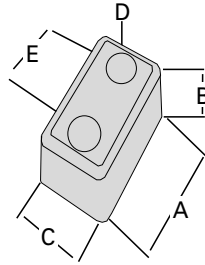

Minimum of 12

### Rubber bumper

Prod. #: 625-6092

A: 8 1/2"  
B: 2"  
C: 1 7/8"  
Holes: D: 11/32"  
E: 4 7/8"

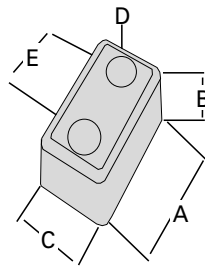

Minimum of 12

### Rubber bumper

Prod. #: 625-6007

A: 7 11/16"  
B: 2"  
C: 2 1/4"  
Holes: D: 3/8"  
E: 4 1/2"

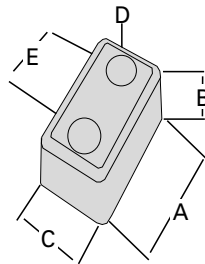

Minimum of 12

\* Personalize your bumpers with your logo (minimum order required).

REV. 05/2011

## Rubber bumpers

Prod. #	Model	Length
625-4354	2	15' or 30' lengths
625-4146	3	15' lengths
625-4033	4	6" without mounting holes
625-4040	4	8"
625-4058	4	10"
625-4065	4	12"
625-2558	4	22"
625-4139	4	30"
625-4072	4	96"
625-4097	4	x feet (or 14' lengths)

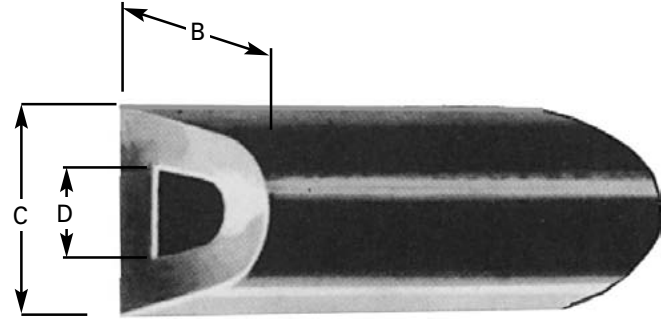

Model	Size
2	B: 1 7/8" C: 2 1/4" D: 1"
3	B: 3" C: 3 1/4" D: 1 1/2"
4	B: 3 3/4" C: 4 1/2" D: 2"

## Heavy duty bumpers

Prod. #	Back	Size
625-6001	Hollow	A: 7 3/8" B: 3 1/2" C: 5 1/2"

4 mounting holes for 1/2" dia. bolts on 3" x 5 1/4" centres

Prod. #	Back	Size
625-6153	Solid	A: 8 1/8" B: 3 5/8" C: 5 3/8"

4 mounting holes for 5/8" dia. bolts on 3 1/8" x 5 1/2" centres

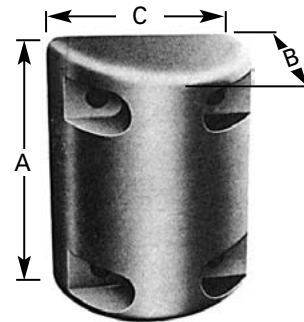

## Roller bumper

Prod. #: 625-0367 Galvanized steel

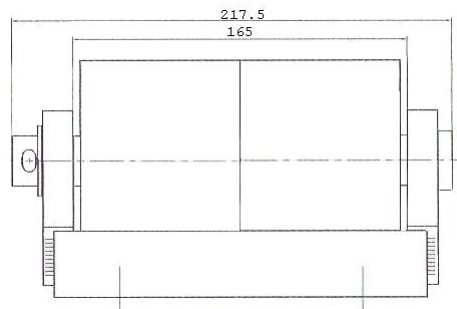
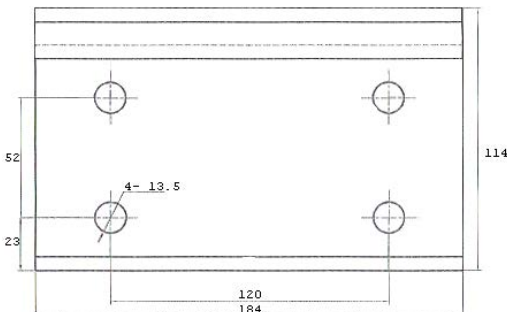
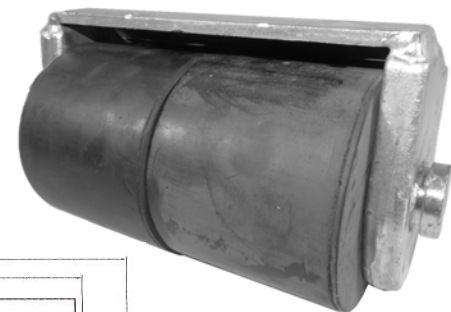

REV. 09/2012

### Wheel chock

Prod. #: **625-6141**

Size: Height: 8"  
Length: 9 1/2"  
Width: 6 1/2"

Rubber wheel chocks for trucks or trailers to comply with labour safety regulations while loading and unloading. With an eye for a chain or steel cable.



### Wheel chock

Prod. #: **625-6261**

Size: Height: 5 9/16"  
Length: 9 3/8"  
Width: 7 5/8"

Rubber wheel chocks for trucks or trailers to comply with labour safety regulations while loading and unloading. With an eye for a chain or steel cable.



### Small wheel chock for "RV"

Prod. #: **625-6254**

Size: Height: 3 3/4"  
Length: 9 1/4"  
Width: 3 7/8"

Rubber wheel chocks for trucks or trailers to comply with labour safety regulations while loading and unloading. With an eye for a chain or steel cable.



### Cast aluminum wheel chock

Prod. #: **625-0159**

Size: Height: 8"  
Teeth: 1"  
Length: 15 1/4"  
Width: 8 3/8"

*Static resistance capacity (stationary 70,000 lbs.)  
Use with vertical support 625-1000.*



### Vertical support

Prod. #: **625-1000**

Size: Thickness: 1 1/2"  
Length: 14 3/4"  
Width: 8 1/2"

Galvanized steel vertical support for aluminum wheel chock.



\* Personalize your bumpers with your logo (minimum order required).

A large grid of graph paper for taking notes, with a small legend box in the bottom right corner indicating that one square equals 1/4 inch.

□ = 1/4"